



Ty-Duct™

T&B Catalog Number: UMC
UPC Number: 78621093912
Description: Wiring Duct Universal Mounting Clip Black

Status: Active

General

Material	Polycarbonate
Color	Black

Dimension Information

Width (inches)	0.65
----------------	------

Packaging

T&B Order Multiple	100
T&B Inner Pack	100
Package in Units	1000
T&B Sold in UOM	Each
T&B Weight Per UOM	0.24 lbs. per 100

Application Support

Product Selector	TD_selector_accessories
T&B Sales Drawings	wsd-000196
Specifications	Available on Website
Overview	Available on Website

Ty-Duct

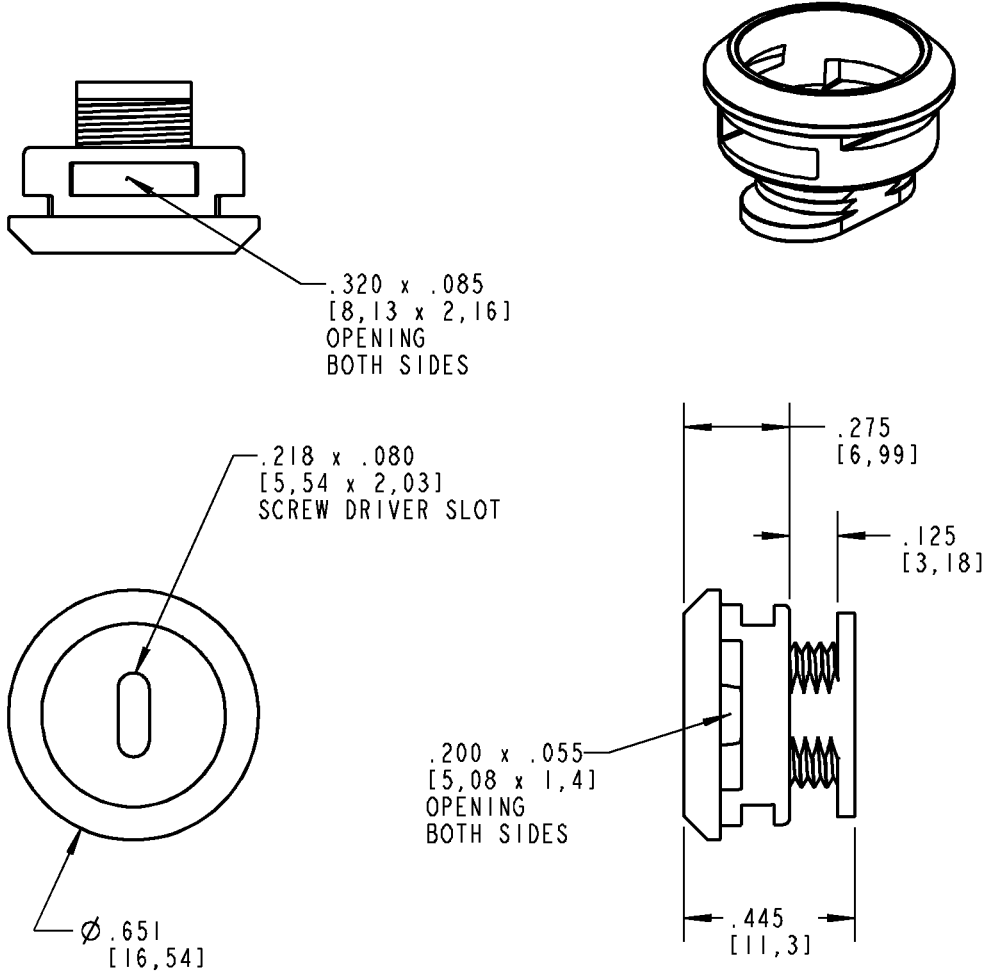

CAT. NO. **UMC**

NOTES:

1. MATERIAL: POLYCARBONATE, BLACK
2. MATERIAL THICKNESS RANGE: .060 - .110 [1,52 - 2,8]
3. MOUNTING HOLE: .551 x .315 [14,0 x 8,0] SLOT
4. ACCOMMODATES CABLE TIES .188 [4,78] AND .320 [8,13] WIDE



GENERAL NOTES		Thomas & Betts			
1. ALL DIMENSIONS ARE FOR REFERENCE ONLY. 2. DIMENSIONS IN BRACKETS [] ARE IN METRIC UNITS.					
REVISIONS		DESCRIPTION: UNIVERSAL MOUNTING CLIP (COMBO BUTTON)			
- SEE ERN (****) FOR APPROVAL SIGNATURES & RELEASE DATE. PROJECT NO: ****		ORIGINAL PROJECT NO / (ERN NO)	SHEET NO:	REV. NO:	DRAWING NO:
		FD55400 / (2005923)	1 OF 1	-	WSD-000196

Trust Thomas and Betts for all your wiring accessories!

Features include:

- Divider Walls, enabling multiple channels to be created within a duct channel
- Universal Mounting Clips that secure channels and wires
- Corner Strips that keep corners rigid at tee junctions when used for control panel applications
- Joining Strips to unite sections of duct and keep the wall rigid
- Plastic Rivets for securing ducts quickly and easily

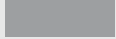
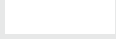
[_] = space for color identifier:

G = Gray	
W = White	
B = Black	
I = Intrinsic Blue	

Create multiple channels inside wiring ducts!

Divider Wall

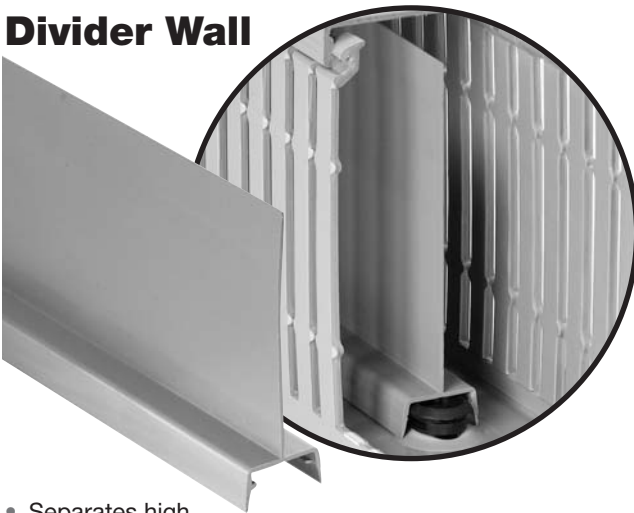

- Separates high and low voltage to reduce shortages and interference
- Mount inside any Ty-Duct™ PVC wiring duct using Universal Mounting Clips
- Score lines enable sections to be removed
- Solid and Wide Slotted style

CAT. NO.	DESCRIPTION	LENGTH (FT.)	STD. CTN. QTY
TY1D [_] P [_] 6	1" High Wall Divider	6	120
TY1.5D [_] P [_] 6	1.5" High Wall Divider	6	120
TY2D [_] P [_] 6	2" High Wall Divider	6	120
TY3D [_] P [_] 6	3" High Wall Divider	6	120
TY4D [_] P [_] 6	4" High Wall Divider	6	120
TY5D [_] P [_] 6	5" High Wall Divider	6	120

Catalog Number must be completed by adding suffix *S* for Solid or *W* for Wide Slot.

Example: TY2DSPG6 is a 2" high solid wall gray divider.

Catalog Number must be completed by adding suffix *G* for Gray, *W* for White, *I* for Intrinsic Blue, *B* for Black.

Example: TY2DSPG6 is a 2" high solid wall gray divider.

One size fits all!

Universal Mounting Clips

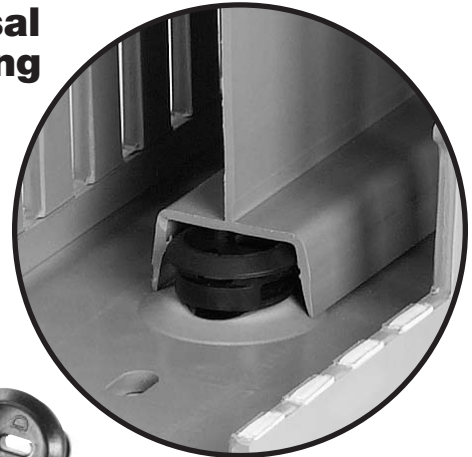

- Added before or after the duct is in place, without additional hardware
- Twists on into place —holds securely
- Installs easily using a screwdriver
- Accommodates up to 40 lb. cable ties
- Black polycarbonate



CAT. NO.	DESCRIPTION	QTY
UMC	Universal Fastener Mount	100 pk